

□ Dimension

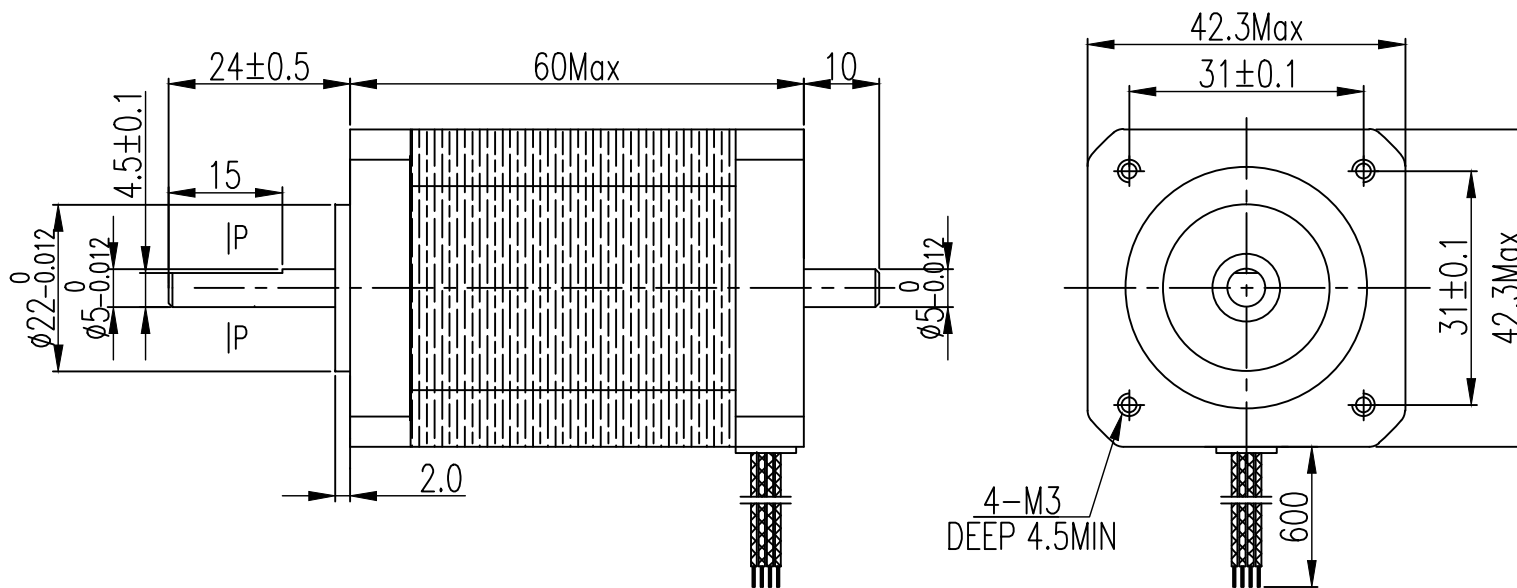

□ SPECIFICATIONS unit=mm

步距角 /STEP ANGEL	1.8° ±5%
相数 /NO. OF PHASES	2
额定电压 /RATED VOLTAGE	5.2 V
额定电流 /RATED CURRENT	1.3 A
电阻 /RESISTANCE	4.0 Ω ±10%
电感 /INDUCTANCE	10.6 mH ±20%
静转矩 /HOLDING TORQUE	85N.cm
绝缘等级 /INSULATION CLASS	CLASS B(130° C)
引出线规格 /LEADSTYLE	UL3266 26AWG

备注/NOTE:

接线图 / WIRING DIAGRAM

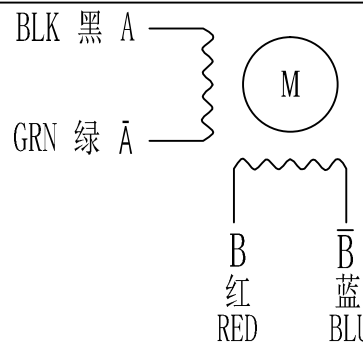

励磁顺序 (2相励磁)  
EXCITING SEQUENCE (2EX)

STEP	励磁顺序				CCW
	A	B	Ā	B̄	
1	+	+	-	-	↑
2	-	+	+	-	
3	-	-	+	+	
4	+	-	-	+	

客户确认&接受 CONFIRMED&ACCEPTED BY CUSTOMER					型号/MODEL:	SL42S260A4D5-2410	
盖章&签名 (COMPANY CHOP&SIGNATURE)							
一般公差 TOLERANCE ±0.3/±0.3°	版本 REV	变更番号 ECO NO.	年月日 DATE	变更内容 REVISIONS	设计 BY	备注 NOTE	REV   A
制图/DRAWN	陈锡泽		比例 SCALE	1:1	品名 TITLE	SHENLI®	
设计/DESIGNED			单位 UNIT	mm	深圳市申力微特电机有限公司 SHENZHEN SHENLI WITT MOTOR CO., LTD		三视图 THIRD ANGLE PROJECTION
审核/CHECKED							
承认/APPROVED							
						页 SHEET	1/1